

1. Drgania własne

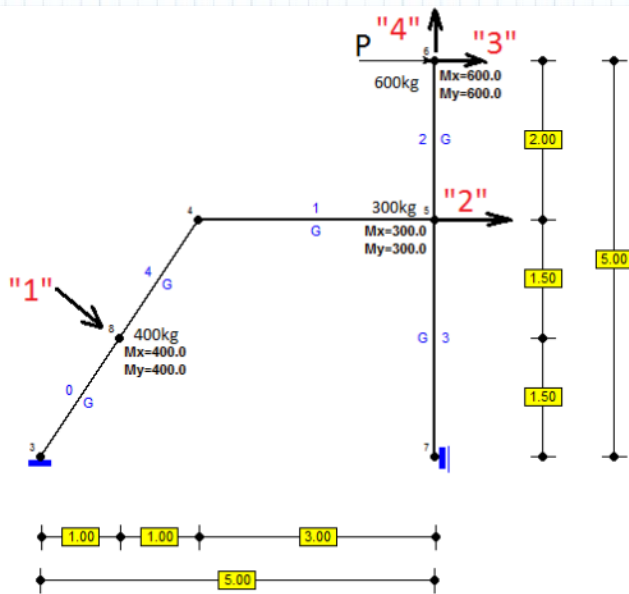

Przekrój IPN200

$$E := 205 \text{ GPa} \quad J := 2140 \text{ cm}^4$$

$$EJ := E \cdot J = 4387 \text{ kN} \cdot \text{m}^2$$

$$P_0 := 8 \text{ kN} \quad \Theta := 12 \frac{\text{rad}}{\text{s}}$$

$$SSNU := R - 3 - P - 3 \cdot O = 2$$

Rama dwukrotnie statycznie niewyznaczalna

$$LSS := 4 \quad \text{- liczba stopni swobody dynamicznej}$$

$$L_u := \sqrt{(2 \text{ m})^2 + (3 \text{ m})^2} = 3.606 \text{ m}$$

- długość pręta ukośnego

Masy na kierunkach:

$$m_1 := 400 \text{ kg}$$

$$m_2 := 300 \text{ kg}$$

$$m_3 := 600 \text{ kg}$$

$$m_4 := 600 \text{ kg} + 300 \text{ kg} = 900 \text{ kg}$$

zakładamy $m_0 := 100 \text{ kg}$ więc:

$$m'_1 := 4$$

$$m'_2 := 3$$

$$m'_3 := 6$$

$$m'_4 := 9$$

UPMS:

Przyjęta numeracja punktów obliczeń:

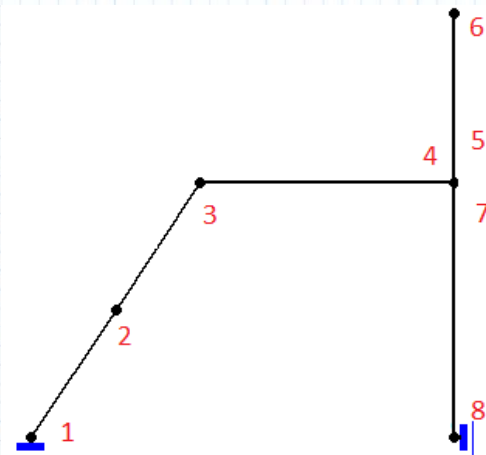
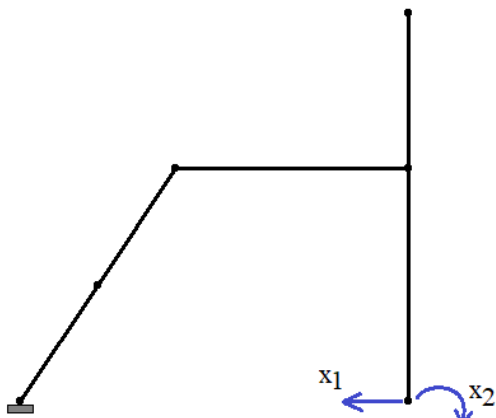

Stan P1

M P1 [m]

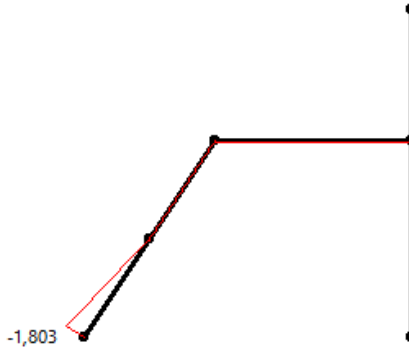
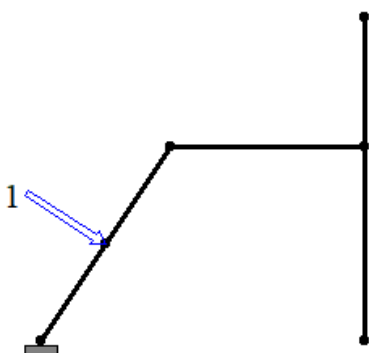

Stan P2

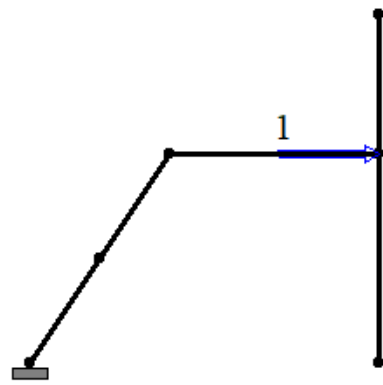

Stan P3

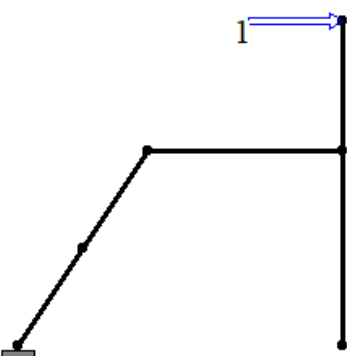

Stan P4

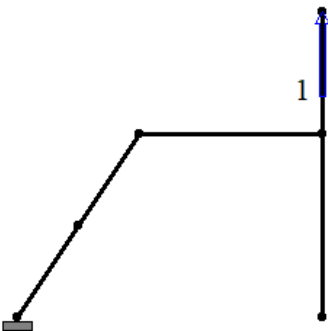

Stan x1=1

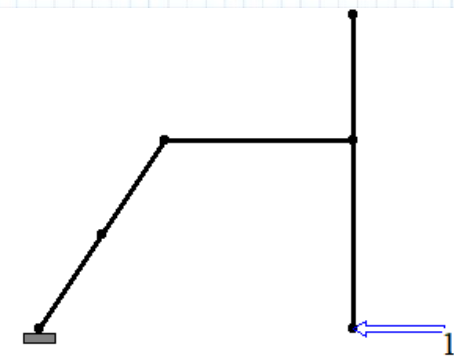

M P2 [m]

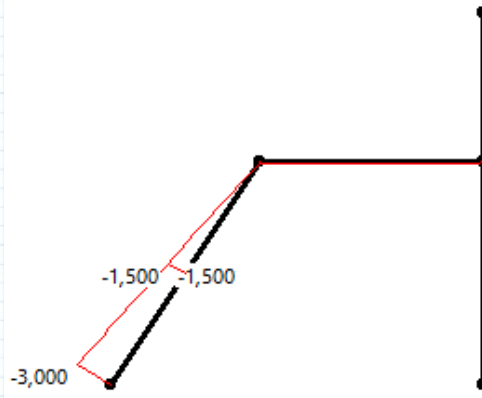

M P3 [m]

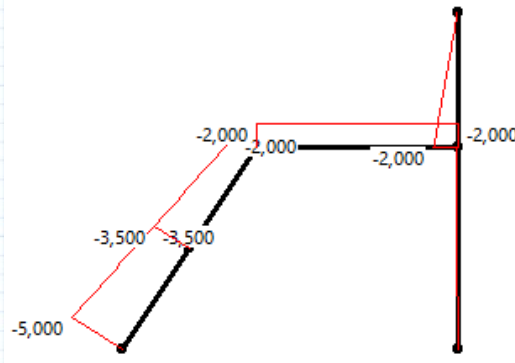

M P4 [m]

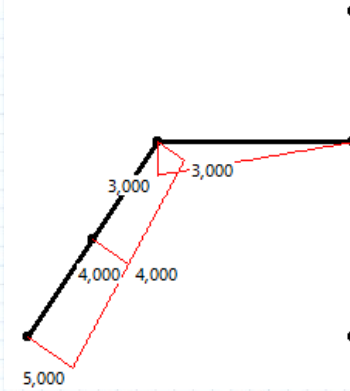

M x1 [m]

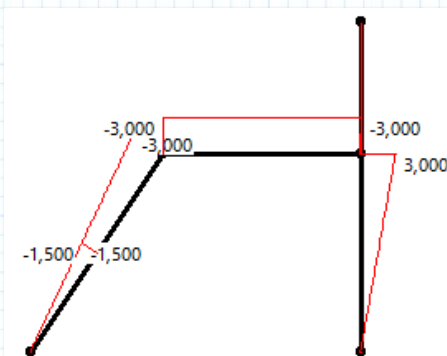

Stan x2=1

M x2 [-]

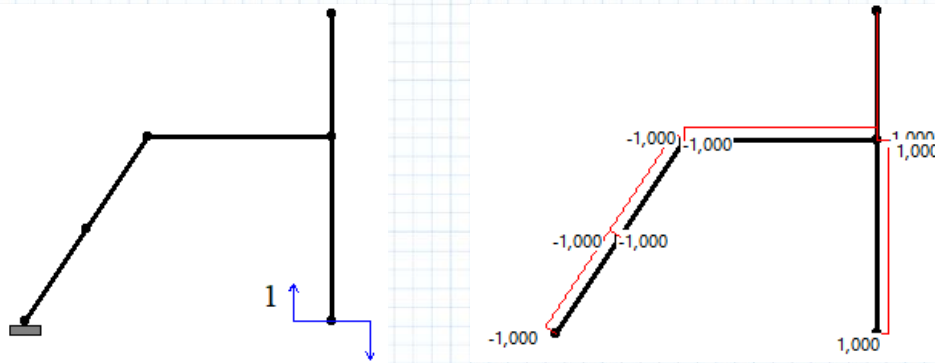

$$EJ \delta_{1p1} := \frac{1}{6} \cdot 1.803 \text{ m} \cdot 1.5 \text{ m} \cdot \frac{L_u}{2} = 0.813 \text{ m}^3$$

$$EJ \delta_{1p2} := \frac{1}{6} \cdot 3 \text{ m} \cdot 3 \text{ m} \cdot L_u = 5.408 \text{ m}^3$$

$$EJ \delta_{1p3} := 3 \text{ m} \cdot L_u \cdot \left(\frac{5 \text{ m}}{6} + \frac{2 \text{ m}}{3} \right) + 3 \text{ m} \cdot 2 \text{ m} \cdot 3 \text{ m} = 34.225 \text{ m}^3$$

$$EJ \delta_{1p4} := 3 \text{ m} \cdot L_u \cdot \left(\frac{-5 \text{ m}}{6} + \frac{-3 \text{ m}}{3} \right) + \frac{1}{2} \cdot 3 \text{ m} \cdot -3 \text{ m} \cdot 3 \text{ m} = -33.331 \text{ m}^3$$

$$EJ \delta_{2p1} := \frac{1}{2} \cdot 1.803 \text{ m} \cdot 1 \cdot \frac{L_u}{2} = 1.625 \text{ m}^2$$

$$EJ \delta_{2p2} := \frac{1}{2} \cdot 3 \text{ m} \cdot 1 \cdot L_u = 5.408 \text{ m}^2$$

$$EJ \delta_{2p3} := 1 \cdot L_u \cdot \frac{5 \text{ m} + 2 \text{ m}}{2} + 2 \text{ m} \cdot 1 \cdot 3 \text{ m} = 18.619 \text{ m}^2$$

$$EJ \delta_{2p4} := 1 \cdot L_u \cdot -\frac{5 \text{ m} + 3 \text{ m}}{2} + \frac{1}{2} \cdot 3 \text{ m} \cdot 1 \cdot -3 \text{ m} = -18.922 \text{ m}^2$$

$$EJ \delta_{11} := \frac{1}{3} \cdot 3 \text{ m} \cdot 3 \text{ m} \cdot L_u + 3 \text{ m} \cdot 3 \text{ m} \cdot 3 \text{ m} + \frac{1}{3} \cdot 3 \text{ m} \cdot 3 \text{ m} \cdot 3 \text{ m} = 46.817 \text{ m}^3$$

$$EJ \delta_{12} := \frac{1}{2} \cdot 3 \text{ m} \cdot 1 \cdot L_u + 3 \text{ m} \cdot 1 \cdot 3 \text{ m} + \frac{1}{2} \cdot 3 \text{ m} \cdot 1 \cdot 3 \text{ m} = 18.908 \text{ m}^2 \quad \delta_{21} := \delta_{12}$$

$$EJ \delta_{22} := 1 \cdot 1 \cdot L_u + 1 \cdot 1 \cdot 3 \text{ m} + 1 \cdot 1 \cdot 3 \text{ m} = 9.606 \text{ m}$$

Układy równań:

$$\delta_{11} \cdot x_{11} + \delta_{12} \cdot x_{21} + \delta_{1p1} = 0$$

$$\delta_{21} \cdot x_{11} + \delta_{22} \cdot x_{21} + \delta_{2p1} = 0$$

$$\delta_{11} \cdot x_{12} + \delta_{12} \cdot x_{22} + \delta_{1p2} = 0$$

$$\delta_{21} \cdot x_{12} + \delta_{22} \cdot x_{22} + \delta_{2p2} = 0$$

$$\delta_{11} \cdot x_{13} + \delta_{12} \cdot x_{23} + \delta_{1p3} = 0$$

$$\delta_{21} \cdot x_{13} + \delta_{22} \cdot x_{23} + \delta_{2p3} = 0$$

$$\delta_{11} \cdot x_{14} + \delta_{12} \cdot x_{24} + \delta_{1p4} = 0$$

$$\delta_{21} \cdot x_{14} + \delta_{22} \cdot x_{24} + \delta_{2p4} = 0$$

Obliczenia:

$$\begin{bmatrix} x_{11} \\ x_{21} \end{bmatrix} := \begin{bmatrix} \delta_{11} & \delta_{12} \\ \delta_{21} & \delta_{22} \end{bmatrix}^{-1} \cdot \begin{bmatrix} -\delta_{1p1} \\ -\delta_{2p1} \end{bmatrix}$$

$$\begin{bmatrix} x_{12} \\ x_{22} \end{bmatrix} := \begin{bmatrix} \delta_{11} & \delta_{12} \\ \delta_{21} & \delta_{22} \end{bmatrix}^{-1} \cdot \begin{bmatrix} -\delta_{1p2} \\ -\delta_{2p2} \end{bmatrix}$$

$$\begin{bmatrix} x_{13} \\ x_{23} \end{bmatrix} := \begin{bmatrix} \delta_{11} & \delta_{12} \\ \delta_{21} & \delta_{22} \end{bmatrix}^{-1} \cdot \begin{bmatrix} -\delta_{1p3} \\ -\delta_{2p3} \end{bmatrix}$$

$$\begin{bmatrix} x_{14} \\ x_{24} \end{bmatrix} := \begin{bmatrix} \delta_{11} & \delta_{12} \\ \delta_{21} & \delta_{22} \end{bmatrix}^{-1} \cdot \begin{bmatrix} -\delta_{1p4} \\ -\delta_{2p4} \end{bmatrix}$$

Wyniki

$$x_{11} = 0.249 \quad x_{21} = -0.659 \text{ m}$$

$$x_{12} = 0.546 \quad x_{22} = -1.638 \text{ m}$$

$$x_{13} = 0.253 \quad x_{23} = -2.436 \text{ m}$$

$$x_{14} = -0.408 \quad x_{24} = 2.774 \text{ m}$$

Obliczenie momentów ostatecznych:

$$M_{ost1} := \begin{bmatrix} 0 \\ -1.5 \\ -3 \\ -3 \\ 0 \\ 0 \\ 3 \\ 0 \end{bmatrix} m \cdot x_{11} + \begin{bmatrix} -1 \\ -1 \\ -1 \\ -1 \\ 0 \\ 0 \\ 1 \\ 1 \end{bmatrix} \cdot x_{21} + \begin{bmatrix} -1.803 \\ 0 \\ 0 \\ 0 \\ 0 \\ 0 \\ 0 \\ 0 \end{bmatrix} m = \begin{bmatrix} -1.144 \\ 0.286 \\ -0.087 \\ -0.087 \\ 0 \\ 0 \\ 0.087 \\ -0.659 \end{bmatrix} m$$

$$M_{ost2} := \begin{bmatrix} 0 \\ -1.5 \\ -3 \\ -3 \\ 0 \\ 0 \\ 3 \\ 0 \end{bmatrix} m \cdot x_{12} + \begin{bmatrix} -1 \\ -1 \\ -1 \\ -1 \\ 0 \\ 0 \\ 1 \\ 1 \end{bmatrix} \cdot x_{22} + \begin{bmatrix} -3 \\ -1.5 \\ 0 \\ 0 \\ 0 \\ 0 \\ 0 \\ 0 \end{bmatrix} m = \begin{bmatrix} -1.362 \\ -0.681 \\ 0 \\ 0 \\ 0 \\ 0 \\ 0 \\ -1.638 \end{bmatrix} m$$

$$M_{ost3} := \begin{bmatrix} 0 \\ -1.5 \\ -3 \\ -3 \\ 0 \\ 0 \\ 3 \\ 0 \end{bmatrix} m \cdot x_{13} + \begin{bmatrix} -1 \\ -1 \\ -1 \\ -1 \\ 0 \\ 0 \\ 1 \\ 1 \end{bmatrix} \cdot x_{23} + \begin{bmatrix} -5 \\ -3.5 \\ -2 \\ -2 \\ -2 \\ 0 \\ 0 \\ 0 \end{bmatrix} m = \begin{bmatrix} -2.564 \\ -1.443 \\ -0.322 \\ -0.322 \\ -2 \\ 0 \\ -1.678 \\ -2.436 \end{bmatrix} m$$

$$M_{ost4} := \begin{bmatrix} 0 \\ -1.5 \\ -3 \\ -3 \\ 0 \\ 0 \\ 3 \\ 0 \end{bmatrix} m \cdot x_{14} + \begin{bmatrix} -1 \\ -1 \\ -1 \\ -1 \\ 0 \\ 0 \\ 1 \\ 1 \end{bmatrix} \cdot x_{24} + \begin{bmatrix} 5 \\ 4 \\ 3 \\ 0 \\ 0 \\ 0 \\ 0 \\ 0 \end{bmatrix} m = \begin{bmatrix} 2.226 \\ 1.839 \\ 1.451 \\ -1.549 \\ 0 \\ 0 \\ 1.549 \\ 2.774 \end{bmatrix} m$$

Stany ostateczne:

Stan 1

M ost1 [m]

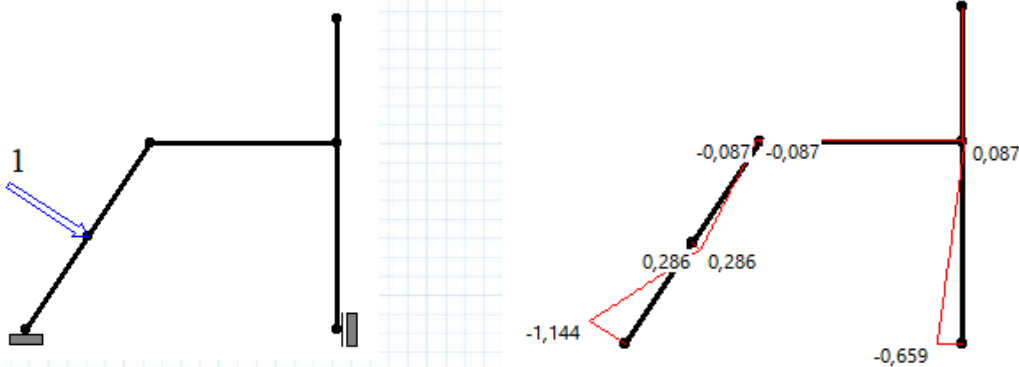

Stan 2

M ost2 [m]

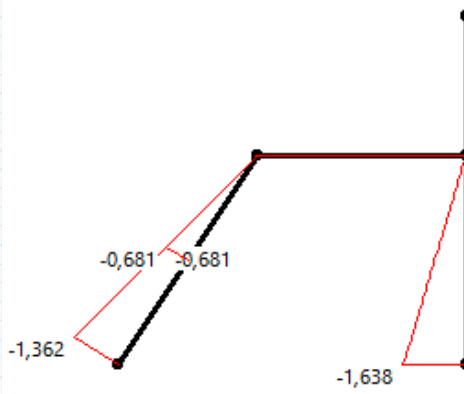
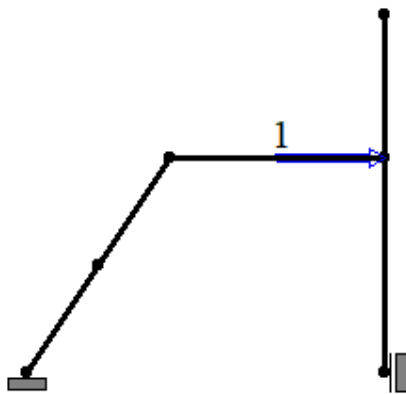

Stan 3

M ost3 [m]

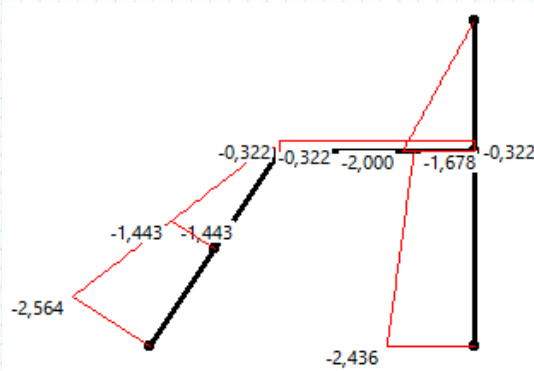
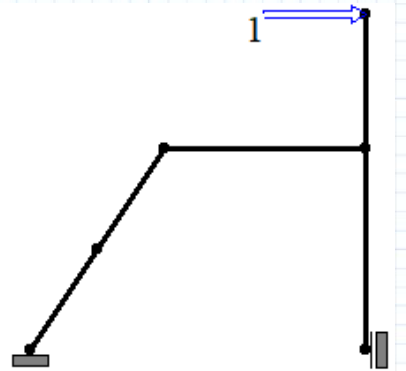

Stan 4

M ost4 [m]

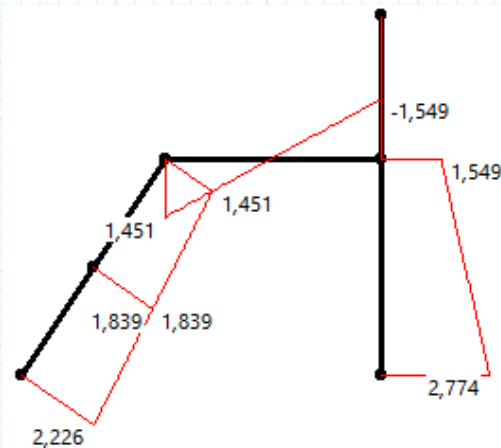
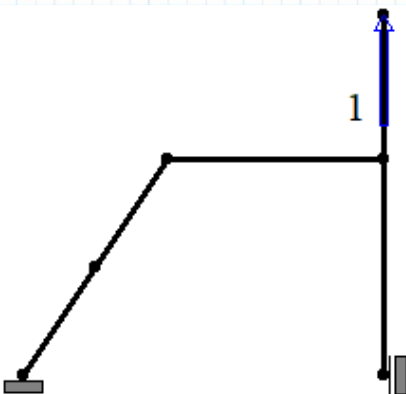

Obliczenie przemieszczeń na kierunkach swobody dynamicznej:

Oznaczenie: $EJ \cdot \delta_{ij} = \delta'_{ij}$

$$EJ \cdot \delta_{11} = \int_S M_{ost1} \cdot M_{p1} dS$$

$$\delta'_{11} := 1.803 \text{ m} \cdot \frac{L_u}{2} \cdot \left(\frac{1.144 \text{ m}}{3} - \frac{0.286 \text{ m}}{6} \right) = 1.085 \text{ m}^3$$

$$EJ \cdot \delta_{12} = \int_S M_{ost2} \cdot M_{p1} dS$$

$$\delta'_{12} := 1.803 \text{ m} \cdot \frac{L_u}{2} \cdot \left(\frac{1.362 \text{ m}}{3} + \frac{0.681 \text{ m}}{6} \right) = 1.845 \text{ m}^3$$

$$EJ \cdot \delta_{13} = \int_S M_{ost3} \cdot M_{p1} dS$$

$$\delta'_{13} := 1.803 \text{ m} \cdot \frac{L_u}{2} \cdot \left(\frac{2.564 \text{ m}}{3} + \frac{1.443 \text{ m}}{6} \right) = 3.56 \text{ m}^3$$

$$EJ \cdot \delta_{14} = \int_S M_{ost4} \cdot M_{p1} dS$$

$$\delta'_{14} := 1.803 \text{ m} \cdot \frac{L_u}{2} \cdot \left(\frac{-2.226 \text{ m}}{3} + \frac{-1.839 \text{ m}}{6} \right) = -3.408 \text{ m}^3$$

$$EJ \cdot \delta_{22} = \int_S M_{ost2} \cdot M_{p2} dS \quad \delta'_{22} := \frac{1}{3} \cdot 3 \text{ m} \cdot L_u \cdot 1.362 \text{ m} = 4.911 \text{ m}^3$$

$$EJ \cdot \delta_{23} = \int_S M_{ost3} \cdot M_{p2} dS \quad \delta'_{23} := 3 \text{ m} \cdot L_u \cdot \left(\frac{2.564 \text{ m}}{3} + \frac{0.322 \text{ m}}{6} \right) = 9.825 \text{ m}^3$$

$$EJ \cdot \delta_{24} = \int_S M_{ost4} \cdot M_{p2} dS \quad \delta'_{24} := 3 \text{ m} \cdot L_u \cdot \left(\frac{-2.226 \text{ m}}{3} + \frac{-1.451 \text{ m}}{6} \right) = -10.642 \text{ m}^3$$

$$EJ \cdot \delta_{33} = \int_S M_{ost3} \cdot M_{p3} dS$$

$$\delta'_{33} := 5 \text{ m} \cdot L_u \cdot \left(\frac{2.564 \text{ m}}{3} + \frac{0.322 \text{ m}}{6} \right) + 2 \text{ m} \cdot L_u \cdot \left(\frac{2.564 \text{ m}}{6} + \frac{0.322 \text{ m}}{3} \right) + 2 \text{ m} \cdot 0.322 \text{ m} \cdot 3 \text{ m} + \frac{1}{3} \cdot 2 \text{ m} \cdot 2 \text{ m} \cdot 2 \text{ m} = 24.829 \text{ m}^3$$

$$EJ \cdot \delta_{34} = \int_S M_{ost3} \cdot M_{p4} dS$$

$$\delta'_{34} := -5 \text{ m} \cdot L_u \cdot \left(\frac{2.564 \text{ m}}{3} + \frac{0.322 \text{ m}}{6} \right) - 3 \text{ m} \cdot L_u \cdot \left(\frac{2.564 \text{ m}}{6} + \frac{0.322 \text{ m}}{3} \right) - \frac{1}{2} \cdot 3 \text{ m} \cdot 0.322 \text{ m} \cdot 3 \text{ m} = -23.608 \text{ m}^3$$

$$EJ \cdot \delta_{44} = \int_S M_{ost4} \cdot M_{p4} dS$$

$$\delta'_{44} := 5 \text{ m} \cdot L_u \cdot \left(\frac{2.227 \text{ m}}{3} + \frac{1.451 \text{ m}}{6} \right) + 3 \text{ m} \cdot L_u \cdot \left(\frac{2.227 \text{ m}}{6} + \frac{1.451 \text{ m}}{3} \right) + 3 \text{ m} \cdot 3 \text{ m} \cdot \left(\frac{1.451 \text{ m}}{3} - \frac{1.549 \text{ m}}{6} \right) = 29.018 \text{ m}^3$$

$$\delta'_{21} := \delta'_{12} \quad \delta'_{31} := \delta'_{13} \quad \delta'_{41} := \delta'_{14} \quad \delta'_{32} := \delta'_{23} \quad \delta'_{42} := \delta'_{24} \quad \delta'_{43} := \delta'_{34}$$

$$\delta_{11} := \frac{\delta'_{11}}{EJ} \quad \delta_{12} := \frac{\delta'_{12}}{EJ} \quad \delta_{13} := \frac{\delta'_{13}}{EJ} \quad \delta_{14} := \frac{\delta'_{14}}{EJ} \quad \delta_{31} := \frac{\delta'_{31}}{EJ} \quad \delta_{32} := \frac{\delta'_{32}}{EJ} \quad \delta_{33} := \frac{\delta'_{33}}{EJ} \quad \delta_{34} := \frac{\delta'_{34}}{EJ}$$

$$\delta_{21} := \frac{\delta'_{21}}{EJ} \quad \delta_{22} := \frac{\delta'_{22}}{EJ} \quad \delta_{23} := \frac{\delta'_{23}}{EJ} \quad \delta_{24} := \frac{\delta'_{24}}{EJ} \quad \delta_{41} := \frac{\delta'_{41}}{EJ} \quad \delta_{42} := \frac{\delta'_{42}}{EJ} \quad \delta_{43} := \frac{\delta'_{43}}{EJ} \quad \delta_{44} := \frac{\delta'_{44}}{EJ}$$

Układ równań opisujący ruch:

$$\left(m_1 \cdot \delta_{11} - \frac{1}{\omega^2} \right) \cdot A_1 + m_2 \cdot \delta_{12} \cdot A_2 + m_3 \cdot \delta_{13} \cdot A_3 + m_4 \cdot \delta_{14} \cdot A_4 = 0$$

$$m_1 \cdot \delta_{21} \cdot A_1 + \left(m_2 \cdot \delta_{22} - \frac{1}{\omega^2} \right) \cdot A_2 + m_3 \cdot \delta_{23} \cdot A_3 + m_4 \cdot \delta_{24} \cdot A_4 = 0$$

$$m_1 \cdot \delta_{31} \cdot A_1 + m_2 \cdot \delta_{32} \cdot A_2 + \left(m_3 \cdot \delta_{33} - \frac{1}{\omega^2} \right) \cdot A_3 + m_4 \cdot \delta_{34} \cdot A_4 = 0$$

$$m_1 \cdot \delta_{41} \cdot A_1 + m_2 \cdot \delta_{42} \cdot A_2 + m_3 \cdot \delta_{43} \cdot A_3 + \left(m_4 \cdot \delta_{44} - \frac{1}{\omega^2} \right) \cdot A_4 = 0$$

Podstawienie: $X = \frac{m_0 \cdot \omega^2}{EJ} \text{ m}^3$

$$(m'_1 \cdot \delta'_{11} \cdot X - 1) \cdot A_1 + m'_2 \cdot \delta'_{12} \cdot X \cdot A_2 + m'_3 \cdot \delta'_{13} \cdot X \cdot A_3 + m'_4 \cdot \delta'_{14} \cdot X \cdot A_4 = 0$$

$$m'_1 \cdot \delta'_{21} \cdot X \cdot A_1 + (m'_2 \cdot \delta'_{22} \cdot X - 1) \cdot A_2 + m'_3 \cdot \delta'_{23} \cdot X \cdot A_3 + m'_4 \cdot \delta'_{24} \cdot X \cdot A_4 = 0$$

$$m'_1 \cdot \delta'_{31} \cdot X \cdot A_1 + m'_2 \cdot \delta'_{32} \cdot X \cdot A_2 + (m'_3 \cdot \delta'_{33} \cdot X - 1) \cdot A_3 + m'_4 \cdot \delta'_{34} \cdot X \cdot A_4 = 0$$

$$m'_1 \cdot \delta'_{41} \cdot X \cdot A_1 + m'_2 \cdot \delta'_{42} \cdot X \cdot A_2 + m'_3 \cdot \delta'_{43} \cdot X \cdot A_3 + (m'_4 \cdot \delta'_{44} \cdot X - 1) \cdot A_4 = 0$$

Stąd:

$$\begin{bmatrix} m'_1 \cdot \delta'_{11} \cdot X - 1 & m'_2 \cdot \delta'_{12} \cdot X & m'_3 \cdot \delta'_{13} \cdot X & m'_4 \cdot \delta'_{14} \cdot X \\ m'_1 \cdot \delta'_{21} \cdot X & m'_2 \cdot \delta'_{22} \cdot X - 1 & m'_3 \cdot \delta'_{23} \cdot X & m'_4 \cdot \delta'_{24} \cdot X \\ m'_1 \cdot \delta'_{31} \cdot X & m'_2 \cdot \delta'_{32} \cdot X & m'_3 \cdot \delta'_{33} \cdot X - 1 & m'_4 \cdot \delta'_{34} \cdot X \\ m'_1 \cdot \delta'_{41} \cdot X & m'_2 \cdot \delta'_{42} \cdot X & m'_3 \cdot \delta'_{43} \cdot X & m'_4 \cdot \delta'_{44} \cdot X - 1 \end{bmatrix} \cdot \begin{bmatrix} A_1 \\ A_2 \\ A_3 \\ A_4 \end{bmatrix} = 0$$

Odrzucamy rozwiązanie trywialne:

$$\begin{bmatrix} A_1 \\ A_2 \\ A_3 \\ A_4 \end{bmatrix} \neq 0$$

Więc:

$$f(X) := \begin{vmatrix} m'_1 \cdot \delta'_{11} \cdot X - 1 & m'_2 \cdot \delta'_{12} \cdot X & m'_3 \cdot \delta'_{13} \cdot X & m'_4 \cdot \delta'_{14} \cdot X \\ m'_1 \cdot \delta'_{21} \cdot X & m'_2 \cdot \delta'_{22} \cdot X - 1 & m'_3 \cdot \delta'_{23} \cdot X & m'_4 \cdot \delta'_{24} \cdot X \\ m'_1 \cdot \delta'_{31} \cdot X & m'_2 \cdot \delta'_{32} \cdot X & m'_3 \cdot \delta'_{33} \cdot X - 1 & m'_4 \cdot \delta'_{34} \cdot X \\ m'_1 \cdot \delta'_{41} \cdot X & m'_2 \cdot \delta'_{42} \cdot X & m'_3 \cdot \delta'_{43} \cdot X & m'_4 \cdot \delta'_{44} \cdot X - 1 \end{vmatrix} = 0$$

Szukanie miejsc zerowych wyznacznika, ustawione od najmniejszego do największego:

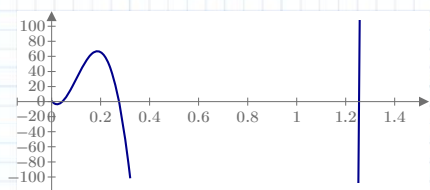

$$f\left(\frac{X}{m^3}\right) \quad X_1 := \frac{0}{m^3} \quad X_2 := \frac{0.05}{m^3} \quad X_3 := \frac{0.3}{m^3} \quad X_4 := \frac{1.2}{m^3}$$

$$\frac{X}{m^3} \left(\frac{1}{m^3} \right)$$

$$X_1 := \text{root}(f(X_1), X_1) = 0.002 \frac{1}{m^3}$$

$$X_2 := \text{root}(f(X_2), X_2) = 0.043 \frac{1}{m^3}$$

$$X_3 := \text{root}(f(X_3), X_3) = 0.275 \frac{1}{m^3}$$

$$X_4 := \text{root}(f(X_4), X_4) = 1.255 \frac{1}{m^3}$$

Obliczenie amplitud drgań własnych:

Są 4 stopnie swobody, więc będą 4 układy równań do (4 formy drgań):

Przy założeniu, że $A_1=1$ układ 4 równań zamienia się na układ 3 równań, z wyrazami wolnymi:

$$(m'_1 \cdot \delta'_{11} \cdot X - 1) \cdot 1 + m'_2 \cdot \delta'_{12} \cdot X \cdot A_2 + m'_3 \cdot \delta'_{13} \cdot X \cdot A_3 + m'_4 \cdot \delta'_{14} \cdot X \cdot A_4 = 0$$

$$m'_1 \cdot \delta'_{21} \cdot X \cdot 1 + (m'_2 \cdot \delta'_{22} \cdot X - 1) \cdot A_2 + m'_3 \cdot \delta'_{23} \cdot X \cdot A_3 + m'_4 \cdot \delta'_{24} \cdot X \cdot A_4 = 0$$

$$m'_1 \cdot \delta'_{31} \cdot X \cdot 1 + m'_2 \cdot \delta'_{32} \cdot X \cdot A_2 + (m'_3 \cdot \delta'_{33} \cdot X - 1) \cdot A_3 + m'_4 \cdot \delta'_{34} \cdot X \cdot A_4 = 0$$

- I forma drgań własnych:

$$A_{11} := 1$$

$$\begin{bmatrix} A_{21} \\ A_{31} \\ A_{41} \end{bmatrix} := \begin{bmatrix} m'_2 \cdot \delta'_{12} \cdot X_1 & m'_3 \cdot \delta'_{13} \cdot X_1 & m'_4 \cdot \delta'_{14} \cdot X_1 \\ m'_2 \cdot \delta'_{22} \cdot X_1 - 1 & m'_3 \cdot \delta'_{23} \cdot X_1 & m'_4 \cdot \delta'_{24} \cdot X_1 \\ m'_2 \cdot \delta'_{32} \cdot X_1 & m'_3 \cdot \delta'_{33} \cdot X_1 - 1 & m'_4 \cdot \delta'_{34} \cdot X_1 \end{bmatrix}^{-1} \cdot - \begin{bmatrix} (m'_1 \cdot \delta'_{11} \cdot X_1 - 1) \cdot A_{11} \\ m'_1 \cdot \delta'_{21} \cdot X_1 \cdot A_{11} \\ m'_1 \cdot \delta'_{31} \cdot X_1 \cdot A_{11} \end{bmatrix} = \begin{bmatrix} 2.957 \\ 6.84 \\ -7.66 \end{bmatrix}$$

$$A_{11} = 1 \quad A_{21} = 2.957 \quad A_{31} = 6.84 \quad A_{41} = -7.66$$

- II forma drgań własnych:

$$A_{12} := 1$$

$$\begin{bmatrix} A_{22} \\ A_{32} \\ A_{42} \end{bmatrix} := \begin{bmatrix} m'_2 \cdot \delta'_{12} \cdot X_2 & m'_3 \cdot \delta'_{13} \cdot X_2 & m'_4 \cdot \delta'_{14} \cdot X_2 \\ m'_2 \cdot \delta'_{22} \cdot X_2 - 1 & m'_3 \cdot \delta'_{23} \cdot X_2 & m'_4 \cdot \delta'_{24} \cdot X_2 \\ m'_2 \cdot \delta'_{32} \cdot X_2 & m'_3 \cdot \delta'_{33} \cdot X_2 - 1 & m'_4 \cdot \delta'_{34} \cdot X_2 \end{bmatrix}^{-1} \cdot - \begin{bmatrix} (m'_1 \cdot \delta'_{11} \cdot X_2 - 1) \cdot A_{12} \\ m'_1 \cdot \delta'_{21} \cdot X_2 \cdot A_{12} \\ m'_1 \cdot \delta'_{31} \cdot X_2 \cdot A_{12} \end{bmatrix} = \begin{bmatrix} 0.676 \\ 6.26 \\ 3.871 \end{bmatrix}$$

$$A_{12} = 1 \quad A_{22} = 0.676 \quad A_{32} = 6.26 \quad A_{42} = 3.871$$

- III forma drgań własnych:

$$A_{13} := 1$$

$$\begin{bmatrix} A_{23} \\ A_{33} \\ A_{43} \end{bmatrix} := \begin{bmatrix} m'_2 \cdot \delta'_{12} \cdot X_3 & m'_3 \cdot \delta'_{13} \cdot X_3 & m'_4 \cdot \delta'_{14} \cdot X_3 \\ m'_2 \cdot \delta'_{22} \cdot X_3 - 1 & m'_3 \cdot \delta'_{23} \cdot X_3 & m'_4 \cdot \delta'_{24} \cdot X_3 \\ m'_2 \cdot \delta'_{32} \cdot X_3 & m'_3 \cdot \delta'_{33} \cdot X_3 - 1 & m'_4 \cdot \delta'_{34} \cdot X_3 \end{bmatrix}^{-1} \cdot - \begin{bmatrix} (m'_1 \cdot \delta'_{11} \cdot X_3 - 1) \cdot A_{13} \\ m'_1 \cdot \delta'_{21} \cdot X_3 \cdot A_{13} \\ m'_1 \cdot \delta'_{31} \cdot X_3 \cdot A_{13} \end{bmatrix} = \begin{bmatrix} 1.125 \\ -0.229 \\ 0.066 \end{bmatrix}$$

$$A_{13} = 1 \quad A_{23} = 1.125 \quad A_{33} = -0.229 \quad A_{43} = 0.066$$

- IV forma drgań własnych:

$$A_{14} := 1$$

$$\begin{bmatrix} A_{24} \\ A_{34} \\ A_{44} \end{bmatrix} := \begin{bmatrix} m'_2 \cdot \delta'_{12} \cdot X_4 & m'_3 \cdot \delta'_{13} \cdot X_4 & m'_4 \cdot \delta'_{14} \cdot X_4 \\ m'_2 \cdot \delta'_{22} \cdot X_4 - 1 & m'_3 \cdot \delta'_{23} \cdot X_4 & m'_4 \cdot \delta'_{24} \cdot X_4 \\ m'_2 \cdot \delta'_{32} \cdot X_4 & m'_3 \cdot \delta'_{33} \cdot X_4 - 1 & m'_4 \cdot \delta'_{34} \cdot X_4 \end{bmatrix}^{-1} \cdot - \begin{bmatrix} (m'_1 \cdot \delta'_{11} \cdot X_4 - 1) \cdot A_{14} \\ m'_1 \cdot \delta'_{21} \cdot X_4 \cdot A_{14} \\ m'_1 \cdot \delta'_{31} \cdot X_4 \cdot A_{14} \end{bmatrix} = \begin{bmatrix} -1.161 \\ 0.026 \\ -0.076 \end{bmatrix}$$

$$A_{14} = 1 \quad A_{24} = -1.161 \quad A_{34} = 0.026 \quad A_{44} = -0.076$$

Formy drgań własnych:

I forma drgań własnych:

$$\omega_1 := \sqrt{\frac{X_1 \cdot EJ}{m_0}} = 10.45 \frac{\text{rad}}{\text{s}}$$

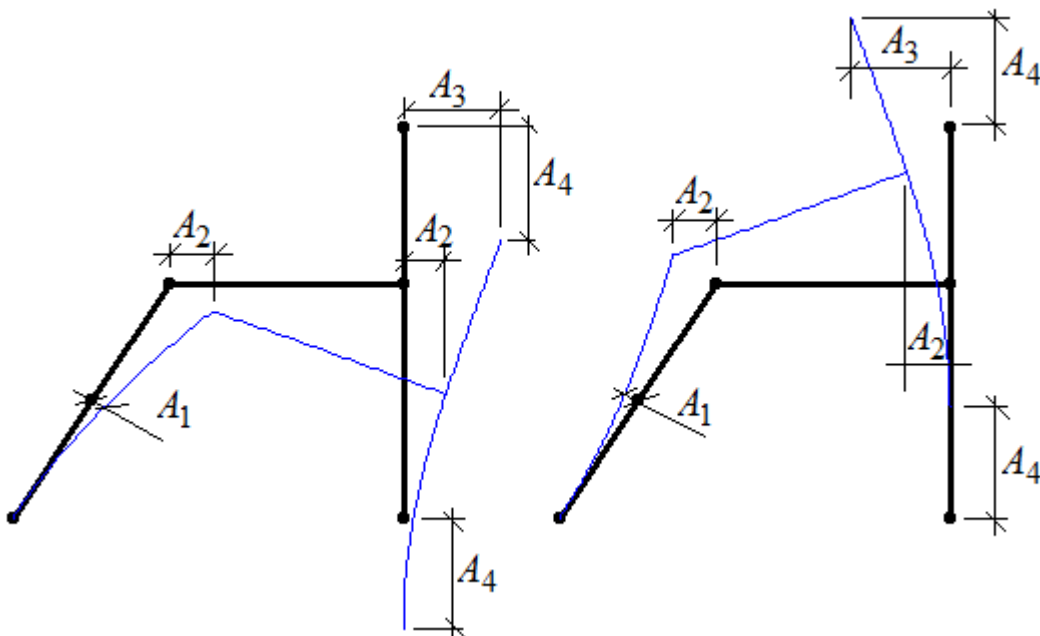

II forma drgań własnych:

$$\omega_2 := \sqrt{\frac{X_2 \cdot EJ}{m_0}} = 43.641 \frac{\text{rad}}{\text{s}}$$

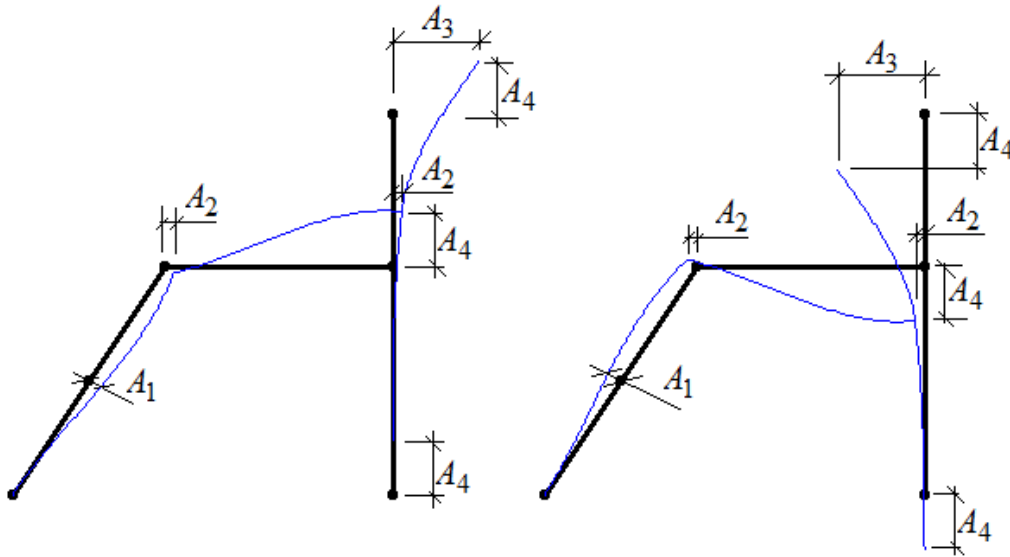

III forma drgań własnych:

$$\omega_3 := \sqrt{\frac{X_3 \cdot EJ}{m_0}} = 109.86 \frac{\text{rad}}{\text{s}}$$

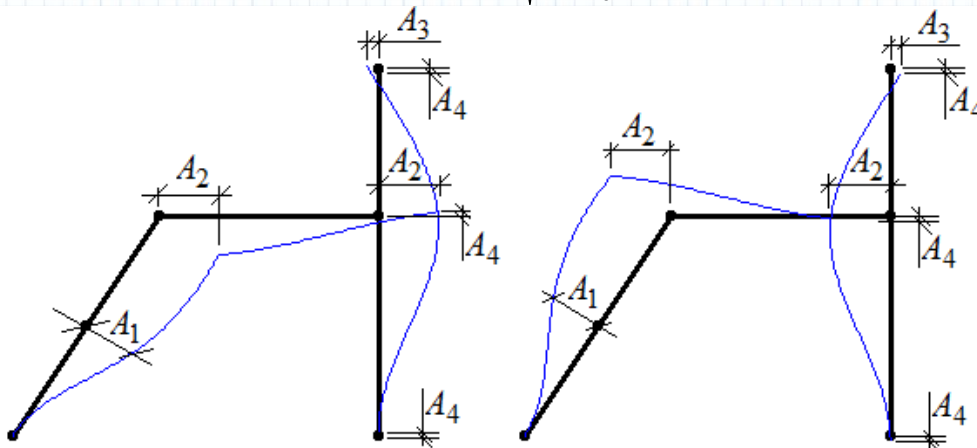

IV forma drgań własnych:

$$\omega_4 := \sqrt{\frac{X_4 \cdot EJ}{m_0}} = 234.601 \frac{\text{rad}}{\text{s}}$$

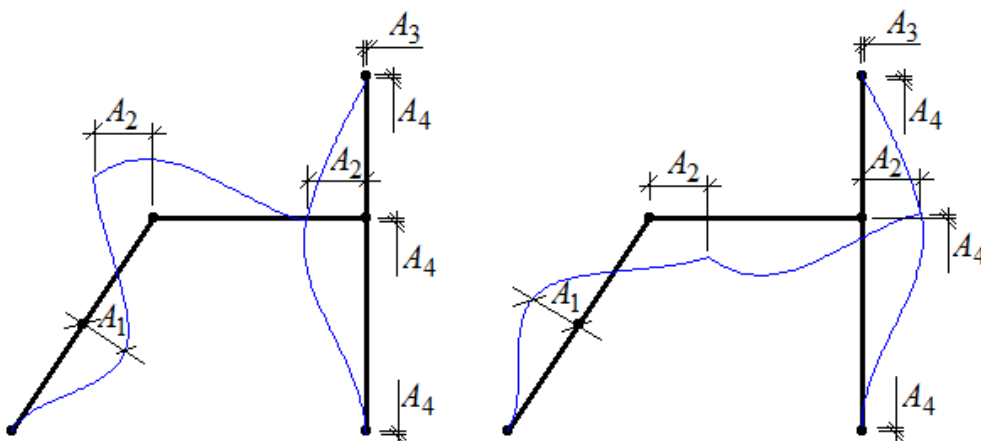

Sprawdzenie ortogonalności:

$$\text{Para 1 i 2: } m_1 \cdot A_{11} \cdot A_{12} + m_2 \cdot A_{21} \cdot A_{22} + m_3 \cdot A_{31} \cdot A_{32} + m_4 \cdot A_{41} \cdot A_{42} = 0 \text{ kg}$$

$$\text{Para 1 i 3: } m_1 \cdot A_{11} \cdot A_{13} + m_2 \cdot A_{21} \cdot A_{23} + m_3 \cdot A_{31} \cdot A_{33} + m_4 \cdot A_{41} \cdot A_{43} = 0 \text{ kg}$$

$$\text{Para 1 i 4: } m_1 \cdot A_{11} \cdot A_{14} + m_2 \cdot A_{21} \cdot A_{24} + m_3 \cdot A_{31} \cdot A_{34} + m_4 \cdot A_{41} \cdot A_{44} = 0 \text{ kg}$$

$$\text{Para 2 i 3: } m_1 \cdot A_{12} \cdot A_{13} + m_2 \cdot A_{22} \cdot A_{23} + m_3 \cdot A_{32} \cdot A_{33} + m_4 \cdot A_{42} \cdot A_{43} = 0 \text{ kg}$$

$$\text{Para 2 i 4: } m_1 \cdot A_{12} \cdot A_{14} + m_2 \cdot A_{22} \cdot A_{24} + m_3 \cdot A_{32} \cdot A_{34} + m_4 \cdot A_{42} \cdot A_{44} = 0 \text{ kg}$$

$$\text{Para 3 i 4: } m_1 \cdot A_{13} \cdot A_{14} + m_2 \cdot A_{23} \cdot A_{24} + m_3 \cdot A_{33} \cdot A_{34} + m_4 \cdot A_{43} \cdot A_{44} = 0 \text{ kg}$$

Sprawdzenie metodą Dunkerlaya i Reileigh'a:

$$\omega_D := \frac{1}{\sqrt{m_1 \cdot \delta_{11} + m_2 \cdot \delta_{22} + m_3 \cdot \delta_{33} + m_4 \cdot \delta_{44}}} = 10.11 \frac{\text{rad}}{\text{s}}$$

$$\delta_1 := m_1 \cdot \delta_{11} + m_2 \cdot \delta_{12} + m_3 \cdot \delta_{13} + m_4 \cdot \delta_{14}$$

$$\delta_2 := m_1 \cdot \delta_{21} + m_2 \cdot \delta_{22} + m_3 \cdot \delta_{23} + m_4 \cdot \delta_{24}$$

$$\delta_3 := m_1 \cdot \delta_{31} + m_2 \cdot \delta_{32} + m_3 \cdot \delta_{33} + m_4 \cdot \delta_{34}$$

$$\delta_4 := m_1 \cdot \delta_{41} + m_2 \cdot \delta_{42} + m_3 \cdot \delta_{43} + m_4 \cdot \delta_{44}$$

$$\omega_R := \frac{\sqrt{m_1 \cdot \delta_1 + m_2 \cdot \delta_2 + m_3 \cdot \delta_3 + m_4 \cdot \delta_4}}{\sqrt{m_1 \cdot \delta_1^2 + m_2 \cdot \delta_2^2 + m_3 \cdot \delta_3^2 + m_4 \cdot \delta_4^2}} = 20.597 \frac{\text{rad}}{\text{s}}$$

$$\omega_D = 10.11 \frac{\text{rad}}{\text{s}} \leq \omega_1 = 10.45 \frac{\text{rad}}{\text{s}} \leq \omega_R = 20.597 \frac{\text{rad}}{\text{s}} \quad \text{warunek spełniony}$$

2. Drgania wymuszone

Sprawdzenie warunku rezonansu:

$$0.9 \omega_1 = 9.405 \frac{\text{rad}}{\text{s}} \leq \Theta = 12 \frac{\text{rad}}{\text{s}} \leq 1.1 \omega_1 = 11.495 \frac{\text{rad}}{\text{s}}$$

$$0.9 \omega_2 = 39.277 \frac{\text{rad}}{\text{s}} \leq \Theta = 12 \frac{\text{rad}}{\text{s}} \leq 1.1 \omega_2 = 48.005 \frac{\text{rad}}{\text{s}}$$

$$0.9 \omega_3 = 98.874 \frac{\text{rad}}{\text{s}} \leq \Theta = 12 \frac{\text{rad}}{\text{s}} \leq 1.1 \omega_3 = 120.846 \frac{\text{rad}}{\text{s}}$$

$$0.9 \omega_4 = 211.141 \frac{\text{rad}}{\text{s}} \leq \Theta = 12 \frac{\text{rad}}{\text{s}} \leq 1.1 \omega_4 = 258.061 \frac{\text{rad}}{\text{s}}$$

Wniosek: rezonans nie zajdzie.

Wymuszenie jest na kierunku 3, więc:

$$\delta_{1P} := \delta_{31} \cdot P_0 = 0.006 \text{ m} \quad \delta_{3P} := \delta_{33} \cdot P_0 = 0.045 \text{ m}$$

$$\delta_{2P} := \delta_{32} \cdot P_0 = 0.018 \text{ m} \quad \delta_{4P} := \delta_{34} \cdot P_0 = -0.043 \text{ m}$$

Wyznaczenie sił bezwładności:

$$\left(\delta_{11} - \frac{1}{m_1 \cdot \Theta^2}\right) \cdot B_1 + \delta_{12} \cdot B_2 + \delta_{13} \cdot B_3 + \delta_{14} \cdot B_4 + \delta_{1P} = 0$$

$$\delta_{11} \cdot B_1 + \left(\delta_{22} - \frac{1}{m_2 \cdot \Theta^2}\right) \cdot B_2 + \delta_{23} \cdot B_3 + \delta_{24} \cdot B_4 + \delta_{2P} = 0$$

$$\delta_{11} \cdot B_1 + \delta_{12} \cdot B_2 + \left(\delta_{33} - \frac{1}{m_3 \cdot \Theta^2}\right) \cdot B_3 + \delta_{34} \cdot B_4 + \delta_{3P} = 0$$

$$\delta_{11} \cdot B_1 + \delta_{12} \cdot B_2 + \delta_{13} \cdot B_3 + \left(\delta_{44} - \frac{1}{m_4 \cdot \Theta^2}\right) \cdot B_4 + \delta_{4P} = 0$$

$$\begin{bmatrix} B_1 \\ B_2 \\ B_3 \\ B_4 \end{bmatrix} := \begin{bmatrix} \delta_{11} - \frac{1}{m_1 \cdot \Theta^2} & \delta_{12} & \delta_{13} & \delta_{14} \\ \delta_{21} & \delta_{22} - \frac{1}{m_2 \cdot \Theta^2} & \delta_{23} & \delta_{24} \\ \delta_{31} & \delta_{32} & \delta_{33} - \frac{1}{m_3 \cdot \Theta^2} & \delta_{34} \\ \delta_{41} & \delta_{42} & \delta_{43} & \delta_{44} - \frac{1}{m_4 \cdot \Theta^2} \end{bmatrix}^{-1} \cdot \begin{bmatrix} \delta_{1P} \\ \delta_{2P} \\ \delta_{3P} \\ \delta_{4P} \end{bmatrix}$$

$$B_1 = -1.046 \text{ kN}$$

$$B_2 = -2.381 \text{ kN}$$

$$B_3 = -10.661 \text{ kN}$$

$$B_4 = 18.983 \text{ kN}$$

Dwa warianty obciążenia statycznego:

D1

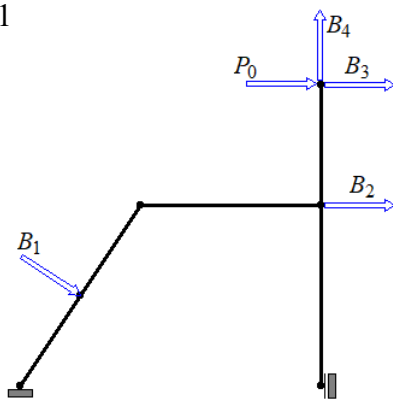

D2

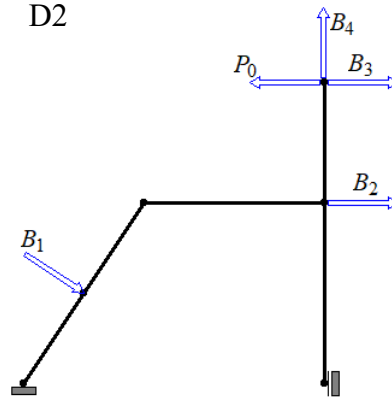

$$M_{D1} := M_{ost1} \cdot B_1 + M_{ost2} \cdot B_2 + M_{ost3} \cdot (B_3 + P_0) + M_{ost4} \cdot B_4$$

$$M_{D2} := M_{ost1} \cdot B_1 + M_{ost2} \cdot B_2 + M_{ost3} \cdot (B_3 - P_0) + M_{ost4} \cdot B_4$$

$$M_{D1} = \begin{bmatrix} 53.528 \\ 40.069 \\ 28.497 \\ -28.451 \\ 5.322 \\ 0 \\ 33.773 \\ 63.72 \end{bmatrix} \text{ kN} \cdot \text{m}$$

$$M_{D2} = \begin{bmatrix} 94.548 \\ 63.159 \\ 33.657 \\ -23.291 \\ 37.322 \\ 0 \\ 60.614 \\ 102.7 \end{bmatrix} \text{ kN} \cdot \text{m}$$

$MD1$ [kNm]

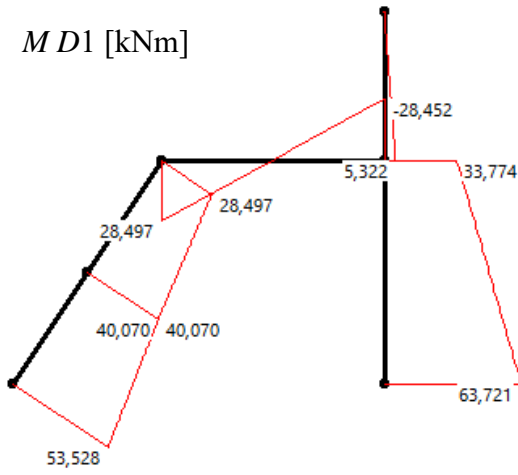

$MD2$ [kNm]

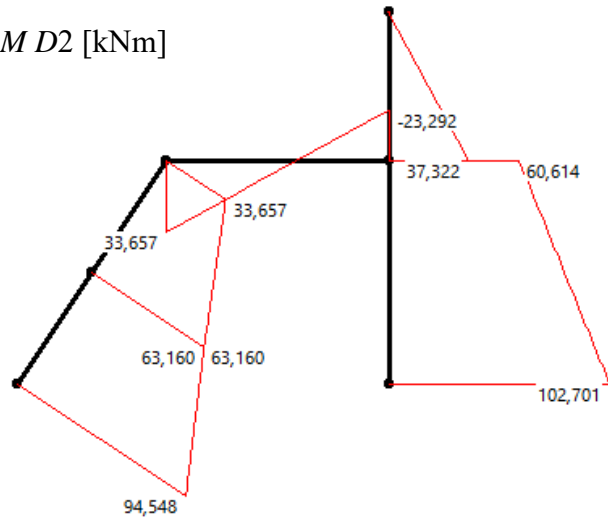

Tnące i normalne ostateczne można obliczyć z poniższego schematu (metoda równoważenia prętów do liczenia tnących i metoda równoważenia węzłów do liczenia normalnych):

$D1$

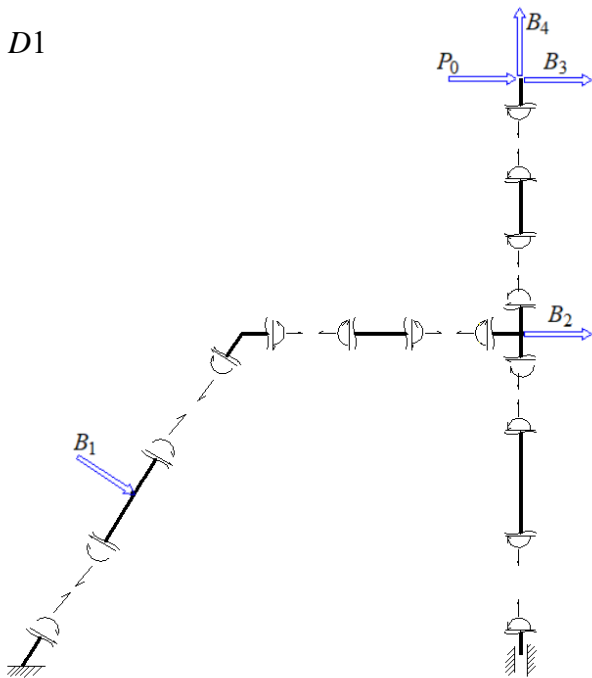

$D2$

